



SMARTLOCK™

Safe, Quick, Strong

Polypropylene Copolymer domestic drainage system, pipes and fittings

Diameter range: 32-63 mm



Table of Contents



4 Technical Specification

6 System Overview

10 System Installation

12 System marking

Technical Catalog

13 Pipes

13 Angle adaptor - Joker

14 Bends

18 Branches

20 Double socket

20 Reducer

21 Collectors

23 Traps

26 Seals, Adaptors & Plugs

28 About Huliot Group

Technical Specification

Property	Value	Test Method
System Brand Name	Smart Lock™	
Application	Domestic drainage system for domestic hot waste water discharge, within the building structure, (application area code “B”) pipes and fittings.	
Pipe Material	Co-polymer PP for the external (black) and the internal (white) layers. Compound of PP and PP-MD for the middle layer.	
Fitting Material	PP and PP-MD	
Connection	Ratchet lock	
Seal Material	TPE elastomeric pressure seal	
Color	Black	
Diameter	Ø 32-63mm	
Pipe Series	S16 / S20	
Minimum Installation Temp.	-25°C	
Waste Water Temp. (Max.)	+95°C Long Term +98°C Short Term	
Chemical Resistance	pH2 - pH12 (Accordance with the instructions of the raw material manufacturer)	DIN 8078
Halogen & Cadmium Content	Free of halogen or cadmium	
UV Resistance	Suitable for external installation when protected from exposure to direct sunlight can be stored outside up to two years	
Construction Standard	SI 958 HR 3.43	
License / Certificates	SKZ, SII	
Green Label	70304	



SMARTLOCK™

The next generation of Domestic drainage



Cost effective

Use of plain end pipe, maximum pipe utilization



Strong

Higher resistance to damage



Storage

Save up to 80% in storage



Quick installation

up to twice as fast



Accurate

Can be installed at extreme angles



Safe

Dual-component injection-molded elastomeric pressure seal



No need for chamfering

and lubricating the pipe



Acoustic system

For Noise reduction



Quarter turn

Ratchet lock



Need a wider angle

JOKER

System Overview

Domestic drainage system, pipes and fittings, diameter range: 32-63 mm

Pipe Raw material: Multilayer PP Copolymer Fittings Raw material: PPMD
System color: Black Sealing: TPE, Dual-component injection-molded elastomeric pressure seal

SKZ Specification for tests and inspection HR 3.43

Drainage and sewage pipes and fittings made of PP with mineral modifiers within the building structure

Israel Standard No. 958 - Polypropylene Pipes And Fittings For Soil And Waste Discharge (low And High Temperature) For Domestic Sanitary Installations License No. 737

Israel Standard No. 71253-1 - Plastics Trap For Installation In Floors. License No. 114783

Israel Standard No. 71253-2 - Plastics Collector For Installation In Floors. License No. 114782

Israel Standard No. 5694 - Waste Fittings For Sanitary Appliances - Requirements And Test Methods License No. 47536

Israel Standard No.14020 - Green Label to mark Smartlock pipe and fitting system License No. 70304





System Advantages

- Quick installation, fitting with built-in seal
- Long-lasting seal
- High ring stiffness
- High chemical resistance
- Highly robust
- High mechanical resistance
- High elasticity modulus and impact resistance
- Smooth pipe interior wall
- High-definition contrast for optical inspection
- Made in Israel
- SKZ Standard Mark
- Use of plain pipes
- No need for chamfer, remove cutting remainders
- No need for pipe lubrication
- Soundproof system performance
- Sag-free piping
- Resistant to harsh weather conditions
- Black polypropylene, UV radiation inhibitor in the pipe
- Life expectancy - 100 years
- Waste water maximum temperature 98° (Short term discontinuous)
- Waste water maximum temperature 95° (Long term discontinuous)
- Minimum Working Temperature -25°C

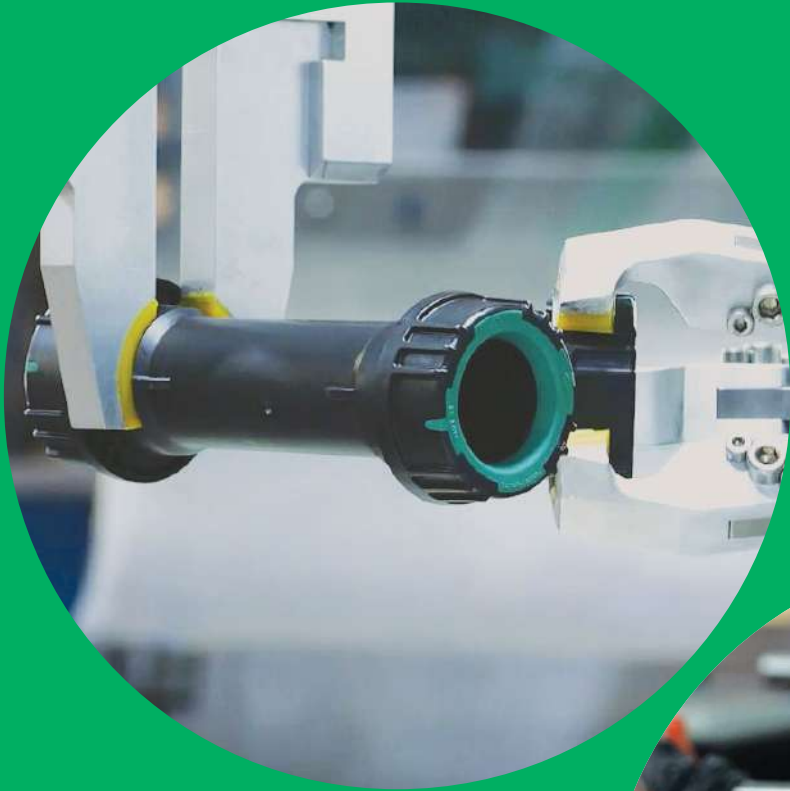

Technology Advantages

The usage of advanced technologies provides substantial advantages to the SMARTLOCK system. The system is manufactured using a full robotic state-of-the-art technology

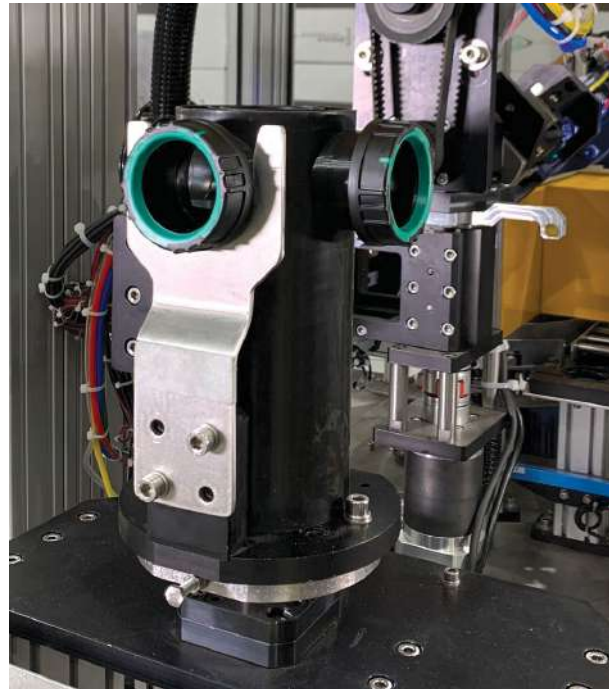
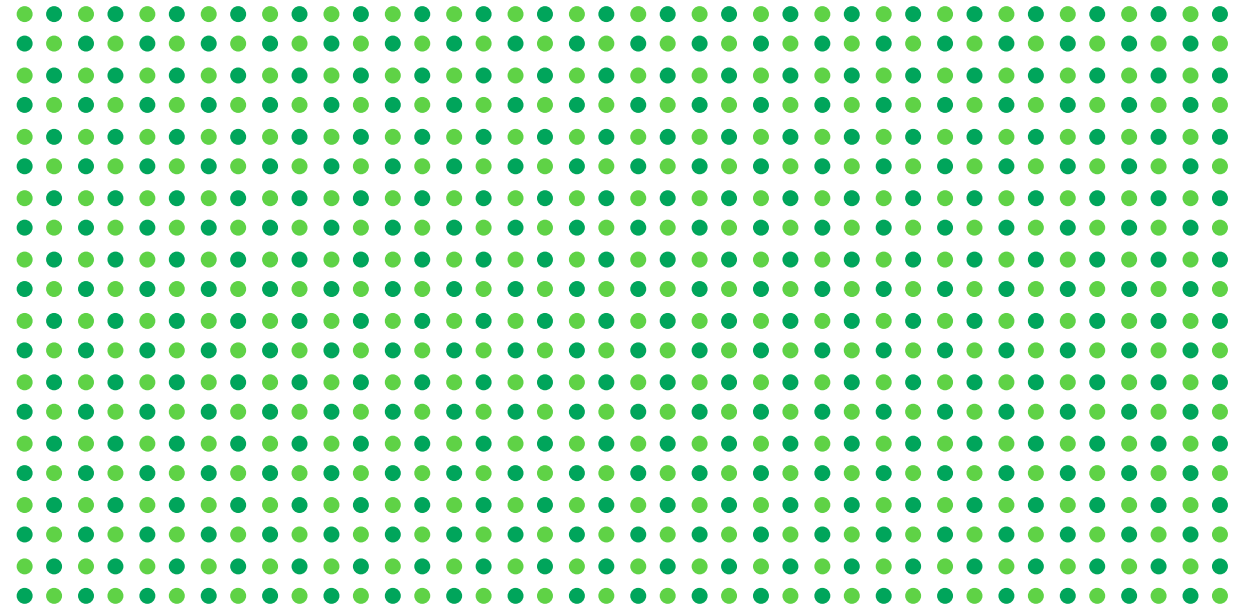

- Each fitting undergoes visual and electronic quality control
- Seals injected using an innovative dual component technology
- Injection machines with integrated process control
- High smoothness grades provided by high end extrusion lines
- Meticulous quality control throughout the entire manufacturing process



System Installation

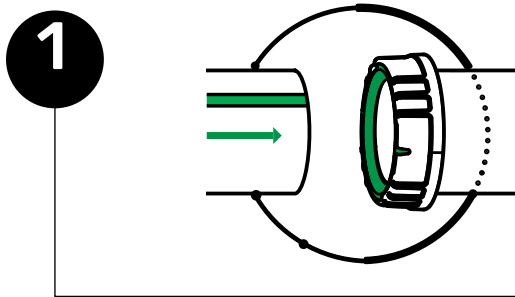

1 Insert the pipe* or fitting up to the stopper

* Remove cutting remainders

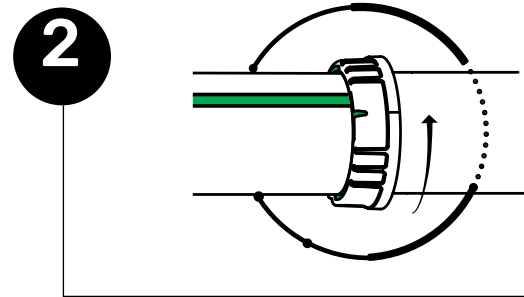

2 Tighten the nut until the ratchet lock

Angle adaptor (Joker) Installation

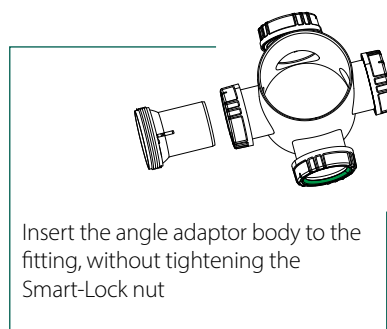
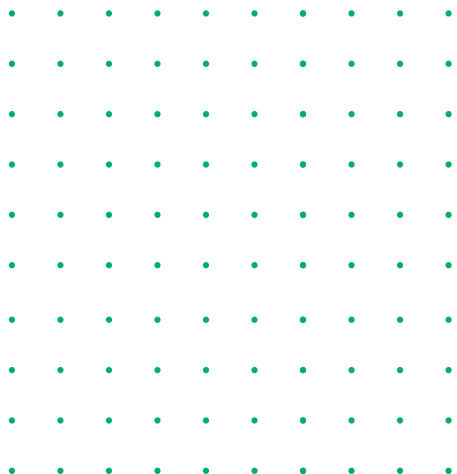

Insert the angle adaptor body to the fitting, without tightening the Smart-Lock nut

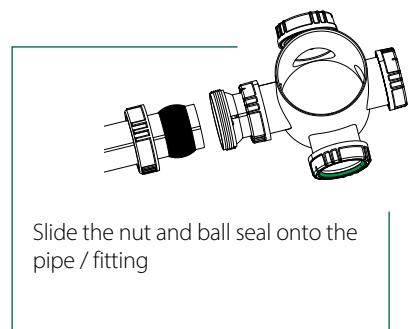

Slide the nut and ball seal onto the pipe / fitting

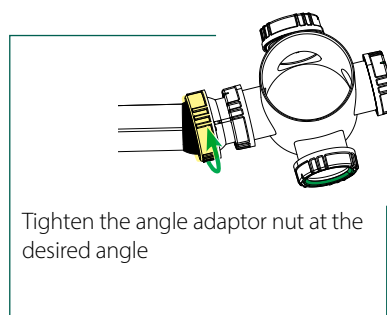

Tighten the angle adaptor nut at the desired angle

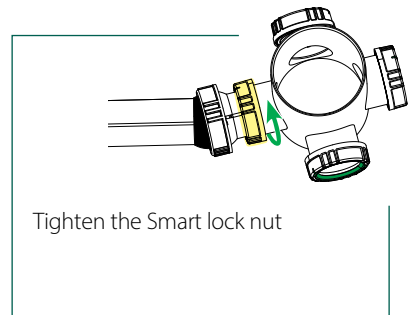

Tighten the Smart lock nut

Installation

Plug Installation in a trap/collector

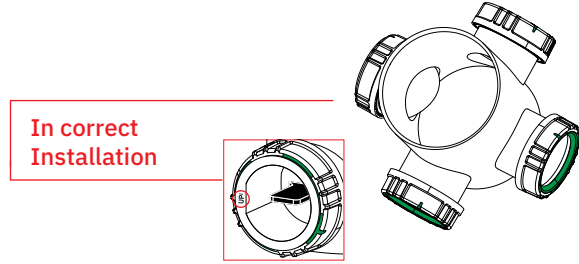
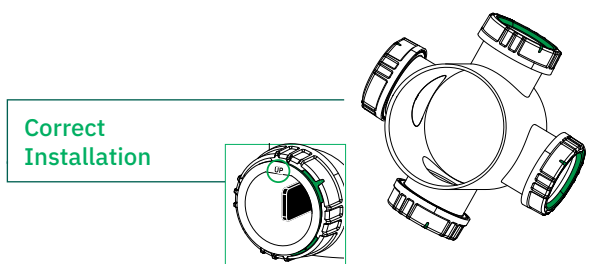
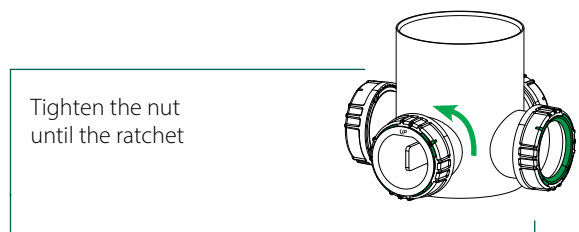
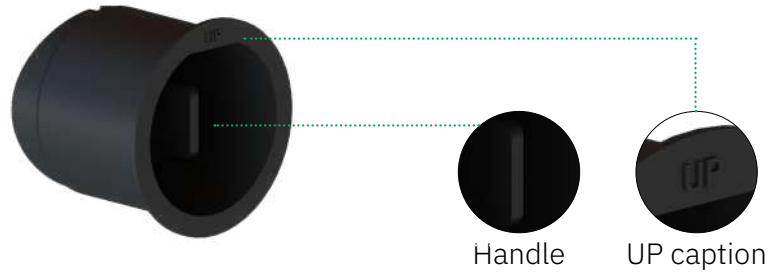

Manual nut assembly



Attention!

The fittings are delivered fully assembled and ready to use.

In case of a deliberate disassembly of the nut, follow the manual nut assembly.

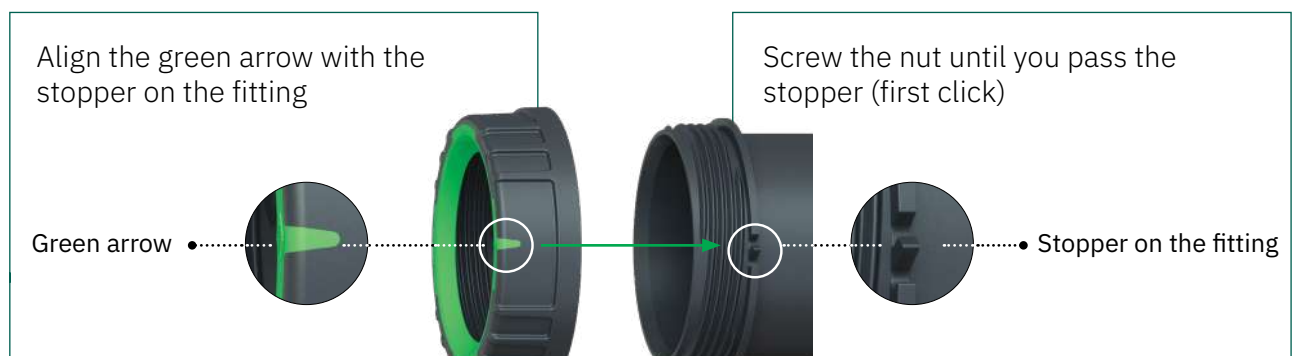

System marking

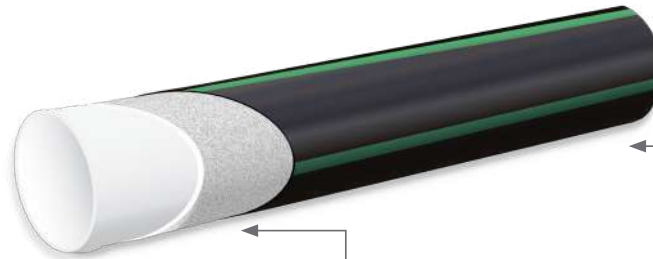

Internal layer

PP Co-polymer (white). provides the best flow performance and high-definition contrast for optical inspection.

Middle layer

PP Co-polymer and PP-MD. provide high mechanical resistance and excellent soundproof performance.

External layer

PP Co-polymer (black). UV radiation inhibitor in the pipe.

Pipe marking

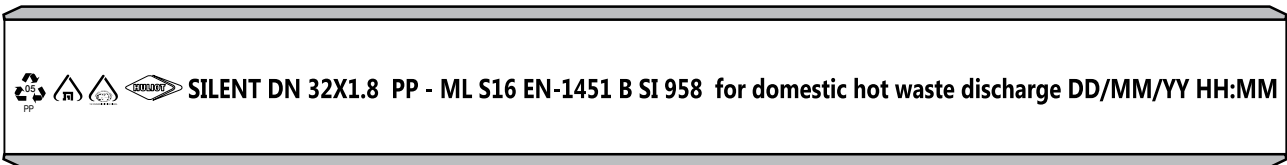

Recyclable product	PP cycle No. 5
Israeli Standard compliant	Standards Institute mark
Green product standard compliant	Green Label mark
Manufacturer logo	Huliot logo
Diameter and wall thickness	DN 32X1.8
Material	PP - ML

Pipe series	S16
For domestic hot waste water discharge	EN-1451
Application area	B
Israeli Standard number	SI 958
Pipe intended use	for domestic hot waste discharge
Production date and time	DD/MM/YY HH:MM

Marking of the fittings

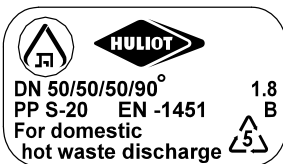



Israeli Standard compliant	Standards Institute mark
Manufacturer logo	Huliot logo
Fitting marking	DN 50/50/50/90
Wall thickness	1.8
Material	PP
Pipe classification	S-20

Plastic piping, PP, for hot wastewater discharge inside buildings	EN-1451
Application area	B
Recyclable product	Recycling symbol
Fitting's intended use	For domestic hot waste discharge



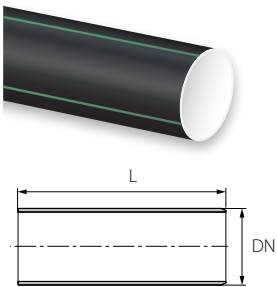

Plain end pipe



Art. no.	DN	L		
64032300	32	3000	20	200
64032400	32	4000	20	200
64041300	40	3000	10	300
64041400	40	4000	10	300
64051300	50	3000	10	200
64051400	50	4000	10	200
64063400	63	4000	10	100

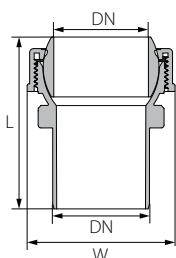

Angle adaptor - Joker



Art. no.	Marking	DN	L	W		
70940160	Angle adaptor 40	40	89	66	100	4,000
70850060	Angle adaptor 50	50	87	77	180	3,200
70963160	Angle adaptor 63	63	95	90	50	2,400

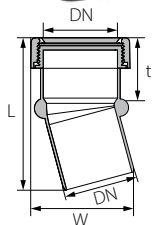

Bend Plain End 15



Art. no.	Marking	DN	t	L	W		
70041150	Plain end 40/15°	40	40	103	60	90	3,780
70051150	Plain end 50/15°	50	41	104	71	90	3,780

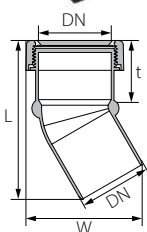

Bend Plain End 30°



Art. no.	Marking	DN	t	L	W		
70041300	Plain end 40/30°	40	41	113	70	90	3,780
70051300	Plain end 50/30°	50	41	111	82	75	3,150

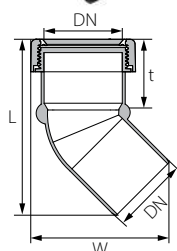

Bend Plain End 45°



Art. no.	Marking	DN	t	L	W		
70041460	Plain End 40/45°	40	40	116	88	90	3,780
70051460	Plain End 50/45°	50	41	114	90	70	2,940

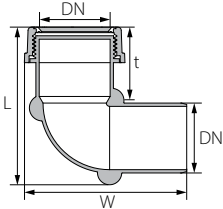

Bend Plain End 90°



Art. no.	Marking	DN	t	L	W		
70041960	Plain End 40/90°	40	40	91	94	90	3,780
70051960	Plain End 50/90°	50	41	107	110	60	2,520

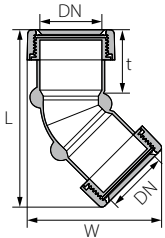

Bend 45°



Art. no.	Marking	DN	t	L	W		
70033460	32/45°	32	35	110	80	110	4,620
70044460	40/45°	40	40	117	89	80	3,360
70055460	50/45°	50	41	127	100	60	2,520
70066463	63/45°	63	50	139	189	55	1,320

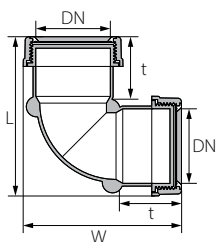

Bend 90°



Art. no.	Marking	DN	t	L	W		
70033960	32/90°	32	35	81	81	110	4,620
70044960	40/90°	40	40	94	94	80	3,360
70055960	50/90°	50	41	110	110	50	2,100

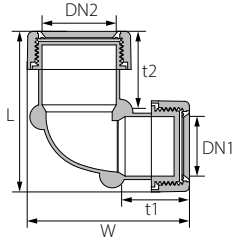

Reducer Bend 90°



Art. no.	Marking	DN1	DN2	t1	t2	L	W		
70043960	32/40/90°	32	40	35	40	88	89	90	3,780
70053960	32/50/90°	32	50	35	41	90	100	80	3,360
70054960	40/50/90°	40	50	40	41	97	107	70	2,940

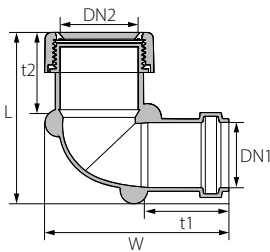

Reducer Bend siphon socket inlet



Art. no.	Marking	DN1	DN2	t1	t2	L	W		
70043930	32/40/90°	32	40	43	40	88	94	90	3,780

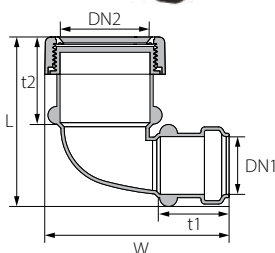

Reducer Bend socket inlet



Art. no.	Marking	DN1	DN2	t1	t2	L	W		
70053930	32/50/90°	32	50	40	41	96	105	80	3,360

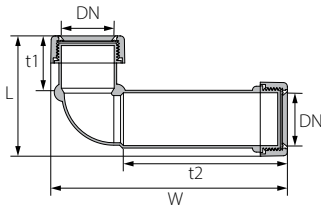

Telescopic Bend



Art. no.	Marking	DN	t1	t2	L	W		
71410960	40/90°	40	40	123	93	183	50	2,100
71450960	50/90°	50	41	156	111	225	35	1,400

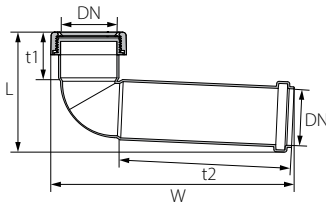

Long Socket inlet bend



Art. no.	Marking	DN	t1	t2	L	W		
71455860	50/50/87.5°	50	41	157	114	222	35	1,400

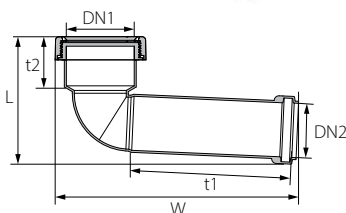

Long Socket inlet reducer bend



Art. no.	Marking	DN1	DN2	t1	t2	L	W		
71456863	50/63/87.5°	63	50	50	157	119	231	30	1,200

Branch 45°



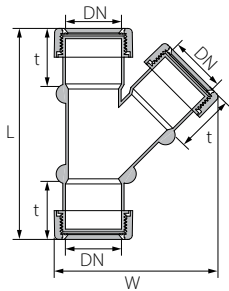

Art. no.	Marking	DN	t	L	W		
70633460	32/45°	32	35	109	150	70	2,800
70644460	40/45°	40	40	120	153	70	1,680
70655460	50/45°	50	41	137	165	60	1,440
70666463	63/45°	63	50	213	176	35	700



Reducer Branch 45°



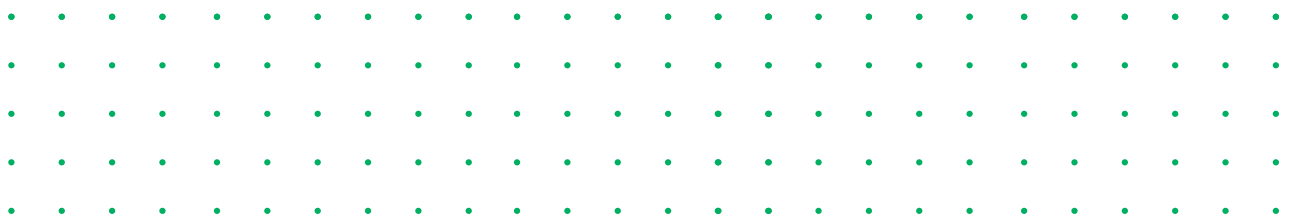
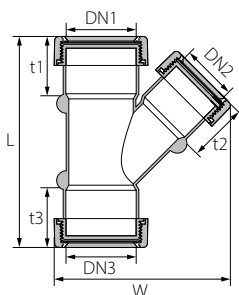

Art. no.	Marking	DN1	DN2	DN3	t1	t2	t3	L	W		
70654460	50/40/50/45°	50	40	50	41	40	41	152	128	80	1,600
72065450	50/50/63/45°	50	50	63	41	41	50	212	169	35	1,470
70665463	63/50/63/45°	63	50	63	50	41	50	213	168	35	700



Branch 90°



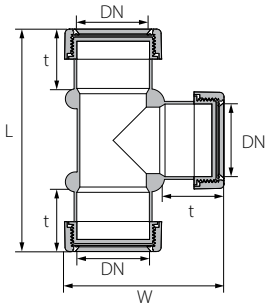

Art. no.	Marking	DN	t	L	W		
70633860	32/90°	32	35	130	90	70	1,680
70644860	40/90°	40	40	155	107	80	1,920
70655860	50/90°	50	41	155	112	60	1,440



Reducer Branch 90°



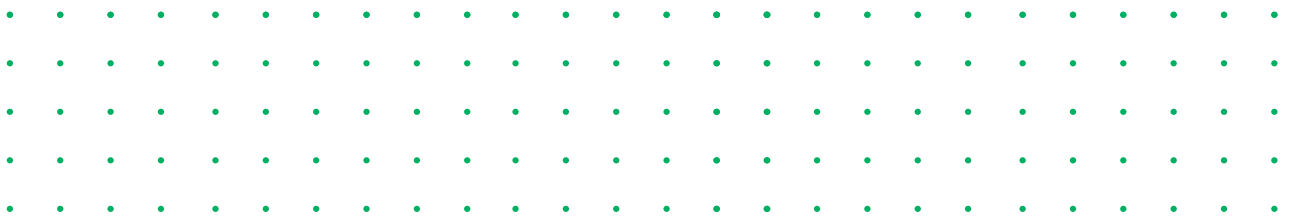
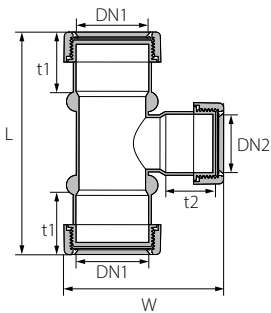

Art. no.	Marking	DN1	DN2	t1	t2	L	W		
70654860	50/40/50/90°	50	40	41	40	155	112	70	1,680

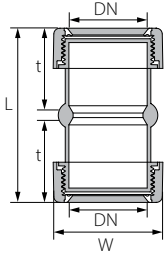

Double socket



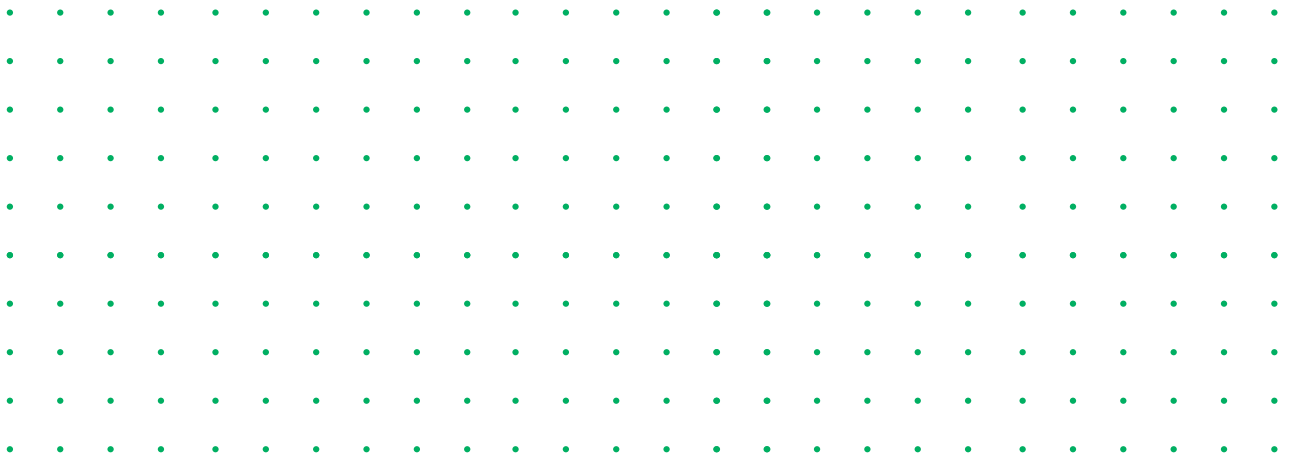

Art. no.	Marking	DN	t	L	W		
70532360	Double socket 32	32	35	90	51	130	5,460
70540460	Double socket 40	40	40	90	58	100	4,200
70550560	Double socket 50	50	41	90	69	80	3,360
70563663	Double socket 63	63	50	113	87	40	1,680



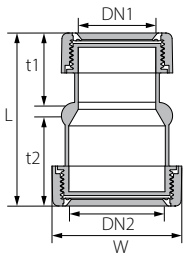

Reducer



Art. no.	Marking	DN1	DN2	t1	t2	L	W		
72143260	32/40	32	40	35	40	82	58	120	5,040
72153260	32/50	32	50	35	41	90	69	90	3,780
72150460	40/50	40	50	40	41	90	69	80	3,360
72163563	50/63	50	63	41	50	132	87	40	1,680

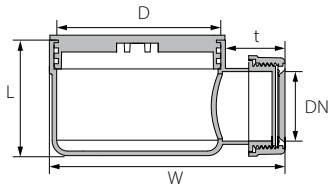

Collector 70/40 Single discharge



Art. no.	Marking	DN	D	t	L	W		
70140760	Single discharge 70/40	40	98.3	40	70	138	60	1,200

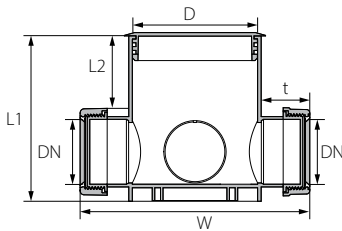

Collector 130



Art. no.	Marking	DN	D	t	L1	L2	W		
70113560	130/50/50	50	98.3	41	130	57	180	20	480

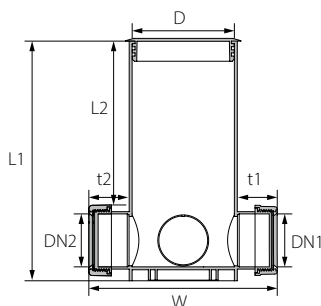

Collector 230



Art. no.	Marking	DN 1	DN 2	D	t1	t2	L1	L2	W		
70123663	230/50/50	50	50	98.3	41	41	230	157	180	14	336
70133563	230/50/63	50	63	98.3	41	50	230	140	191	16	320
70136363	230/63/63	63	63	98.3	50	50	230	140	200	16	240

Down drainage collector 50



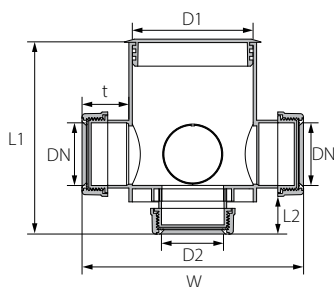

Art. no.	Marking	DN	D1	D2	t	L1	L2	W		
70113562	Down drainage 50	50	98.3	50	41	156	30	180	18	360



Down drainage collector 100



Art. no.	Marking	DN	D1	D2	t	L1	L2	W		
70113566	Down drainage 100	50	98.3	100	41	200	72	180	17	340

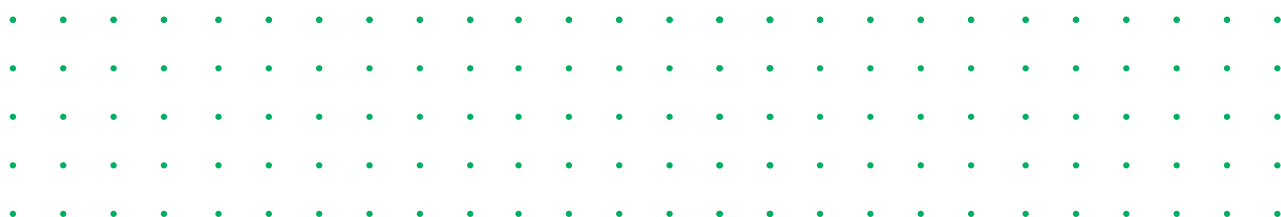
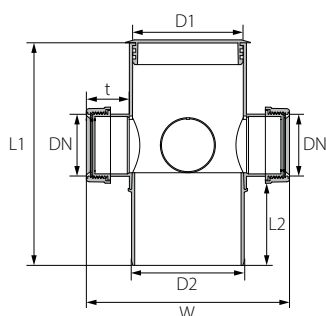

Down drainage collector 110

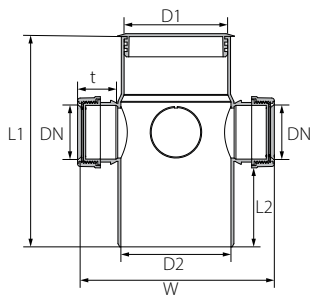

Art. no.	Marking	DN	D1	D2	t	L1	L2	W		
70113565	Down drainage 110	50	98.3	110	41	200	74	180	17	340

Trap 80/50 single discharge

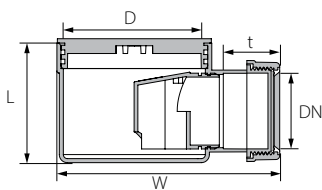

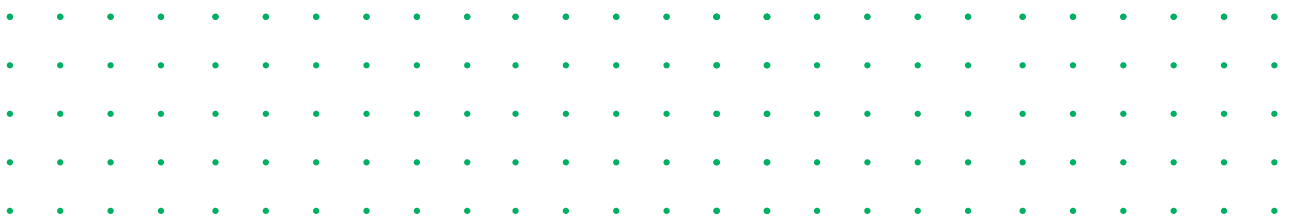

Art. no.	Marking	DN	D	t	L	W		
70145960	Single discharge 80/50	50	98.3	41	80	149	64	1,280



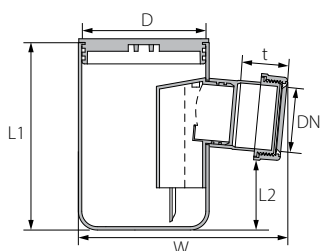

Trap 140/50 single discharge



Art. no.	Marking	DN	D	t	L1	L2	W		
70114500	Single discharge 140/50	50	98.3	41	140	55	165	24	576

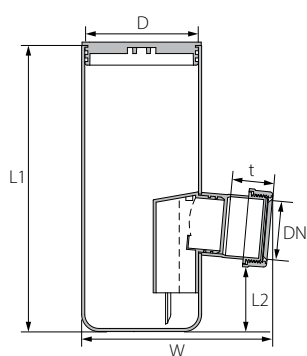

Trap 245/50 single discharge



Art. no.	Marking	DN	D	t	L1	L2	W		
70124599	Single discharge 245/50	50	98.3	41	245	55	165	16	384

Trap 140/40/50 multiple discharge



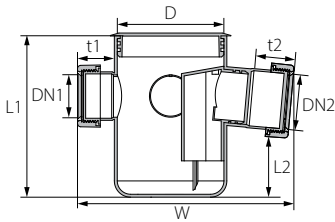

Art. no.	Marking	DN1	DN2	D	t1	t2	L1	L2	W		
70114590	Multiple discharge 140/40/50	40	50	98.3	40	41	140	55	198	18	432



Trap 245/40/50 multiple discharge



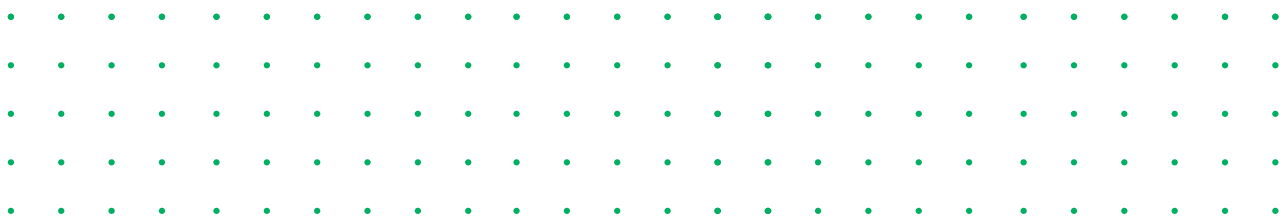
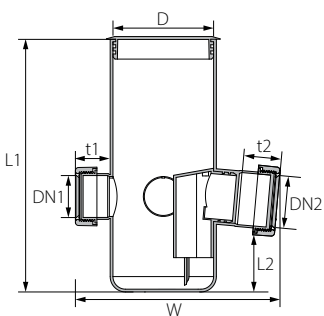

Art. no.	Marking	DN1	DN2	D	t1	t2	L1	L2	W		
70124590	Multiple discharge 245/40/50	40	50	98.3	40	41	245	55	198	12	288



Diagonal Shower Trap 175/50 single discharge



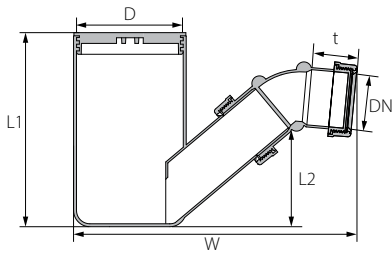

Art. no.	Marking	DN	D	t	L1	L2	W		
70117500	Single discharge 175/50	50	98.3	41	175	55	200	30	600



Diagonal Shower Trap 175/40/50 multiple discharge



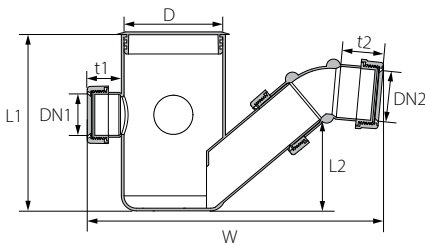

Art. no.	Marking	DN1	DN2	D	t1	t2	L1	L2	W		
70117560	Multiple discharge 175/40/50	40	50	98.3	40	41	175	55	200	18	360



Angle adaptor seal



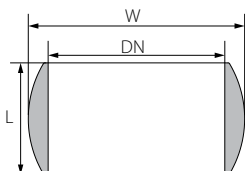

Art. no.	Marking	DN	L	W	Material		
67750440	Angle adaptor seal 40	40	30	50	SBR	750	18,000
67760440	Reducer angle adaptor seal 40-50	40-50	42	60	SBR	500	7,200
67760540	Angle adaptor seal 50	50	30	60	SBR	500	12,000
67763063	Angle adaptor seal 63	63	30.5	73	SBR		



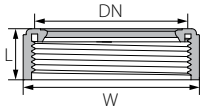

Angle adaptor nut



Art. no.	Marking	DN	L	W		
70950160	Angle adaptor nut 40	40	19	66	450	18,900
70860060	Angle adaptor nut 50	50	22	77	300	12,600
70863063	Angle adaptor nut 63	63	22	90	300	12,000

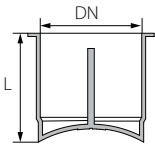

Plug for trap and collector

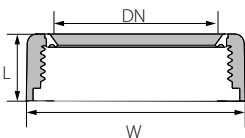

Art. no.	Marking	DN	L		
70940060	Plug for trap 40	40	42	500	24,000
70950060	Plug for trap and collector 50	50	50	300	12,600
70963060	Plug for collector 63	63	68		

Smart Lock Nut



Art. no.	Marking	DN	L	W		
70703260	Nut 32	32	21	51	800	33,600
70704060	Nut 40	40	21	58	550	23,100
70705060	Nut 50	50	21	69	400	16,800
70763063	Nut 63	63	22	87	300	12,600

We Make it Flow.....

Huliot Group is a global leader in advanced flow systems for commercial & residential buildings, bringing complete solutions that cover water supply, wastewater, & infrastructure.

We design, manufacture & market a full range of products that work together in harmony, to deliver a seamless and silent water flow experience, while respecting the environment & keeping it clean.

.....

Huliot Group

Our story begins in 1947 in Sde Nechemiah, a young Kibbutz in the North of Israel. In their quest to build a good future for their families, our founders discovered the market potential of polymethyl-methacrylate (PMMA), a quality plastic used by the Germans, also known as Perspex®. After studying the material and its applications, they opened the doors of Israel's first plastic manufacturing plant in the Upper Galilee, between the fields and the Jordan River, where it stands to this day.

In over 75 years, we have built the company into a leading global group, growing our business both organically and through mergers and acquisitions, deepening our expertise and capturing greater parts of the value chain. Today, Huliot Group owns and operates six manufacturing plants in Israel, India, Slovenia and Portugal, and provides solutions to more than 60 markets worldwide.

Since 2019 Huliot Group is jointly owned by Kibbutz Sde Nehemia (50%) and the Tene Investment Fund (50%).



Our Mission

Like links in a chain (the literal meaning of huliot in Hebrew), our companies work together to enhance the power of water delivery and disposal, from-and-to public infrastructures. Our mission is to create a consistent, quiet water flow for end users in their homes, at work, and in commercial and public buildings, through the delivery of reliable, state-of-the-art solutions.

Our Values



Professionalism



A passion to lead



Integrity and role model



Humility



Achieving goals together



Obligation to our community and environment

Our Products



Domestic Drainage



Acoustic Drainage System



HT Drainage System



Manholes and inspection chambers



Grease & Fat separators

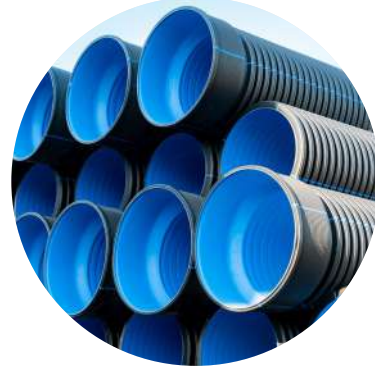

Stormwater management



We Make it Flow

Huliot Group is a global leader in advanced flow systems for commercial and residential buildings, bringing complete solutions that cover water supply, wastewater, and infrastructure.

We design, manufacture and market a full range of products that work together in harmony, to deliver a seamless and silent water flow experience, while respecting the environment and keeping it clean.



PP-R



Fire Protection Networks



Induction Technology

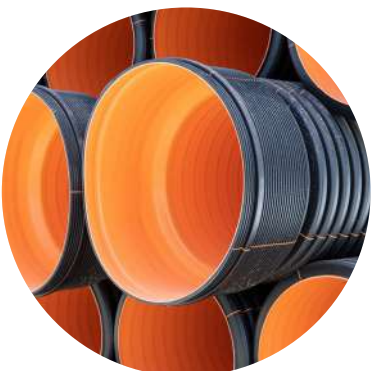

Drainage and sewerage



Multilayer System



PE-X(A) | PE-RT



 **Huliot Group**

 **Huliot Israel**  **Huliot Slovenia**  **Huliot India**  **Huliot Heliroma**  **Huliot Hofit**  **Weisman Friedman**
by Huliot

HULIOT A.C.S. Ltd. Kibbutz Sde-Nechemia, Upper Galilee 1214500, Israel
Tel: +972-4-6946011, Fax: +972-4-6951444 | info@huliot.com

www.huliot.com